



HARMONIZE LATTICE CEILING CLOUD

...

INSTALLATION GUIDE

Solving
Sound
With
Design



Contact us or visit our website
to redesign how your space sounds

WWW.OSONIC.COM
(732) 659 9262

1 - Suspend 2 Short Baffles

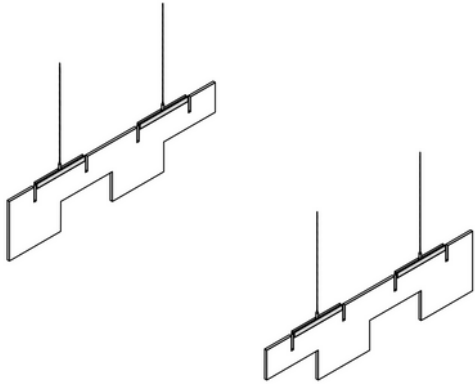

2 - Slot In Long Baffles

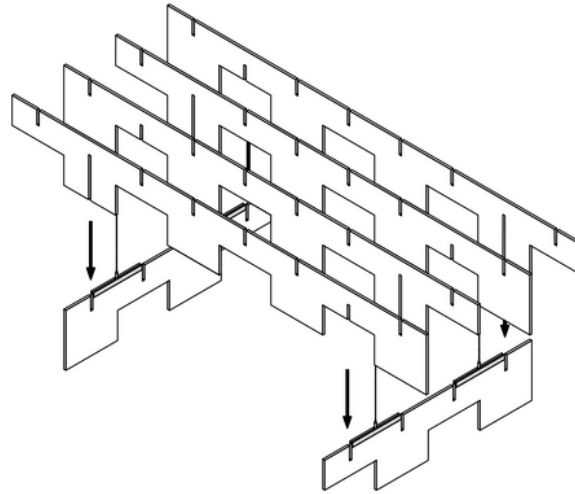

3 - Slot in Remaining Long Baffles

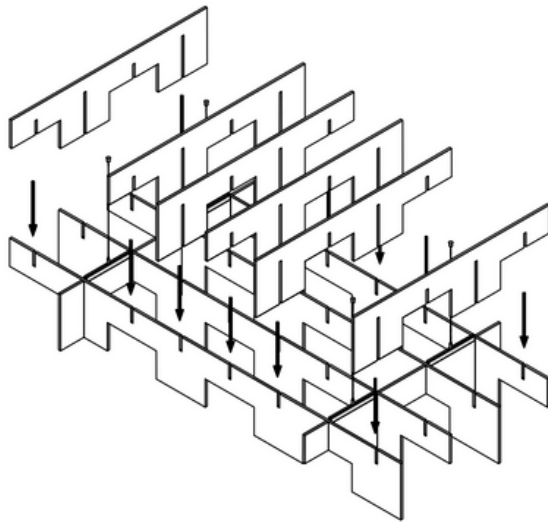

4 - Finished Waves Grid Lattice

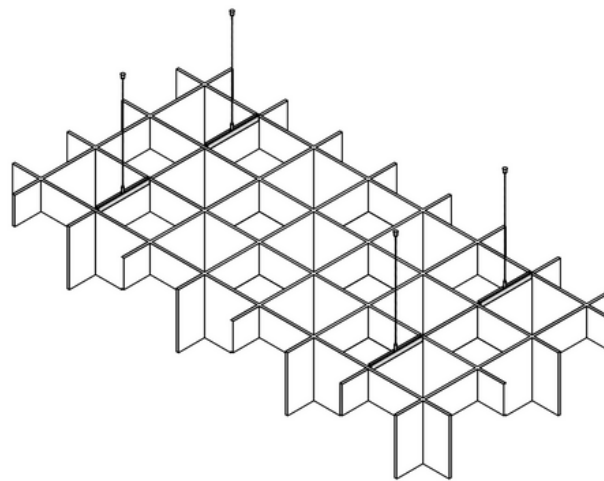

HARMONIZE CEILING ASSEMBLY

TOOLS REQUIRED

Spirit Level/Laser Level

STEPS

1 - Suspend 2 Short Baffles

Suspend the 2 Short baffles with channel and slots pointing upwards. (See Sus-Kit Guide) using a laser level make sure pieces are in line, level and 1500mm apart.

2 - Slot In Long Baffles

Slot the long baffles into the 2 suspended short baffles.

3 - Slot in Short Cross Beams

Slot in the remaining short cross beams to complete the grid lattice.

4 - Finished Harmonize Grid Lattice

Assembly complete.

1 - MARK THE CEILING

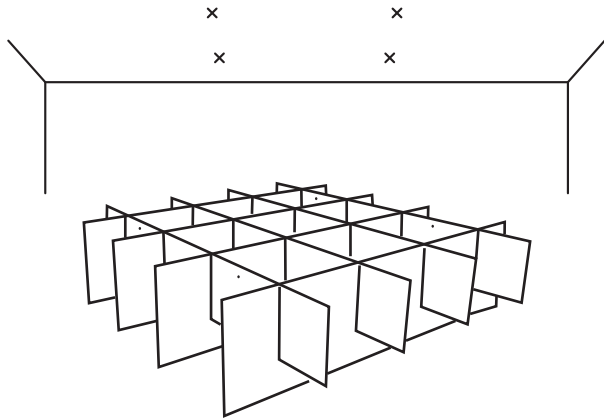

2 - SCREW INTO THE CEILING

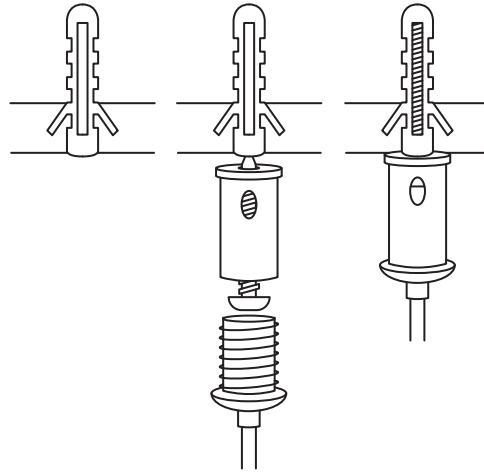

3 - ATTACHING THE CONNECTORS

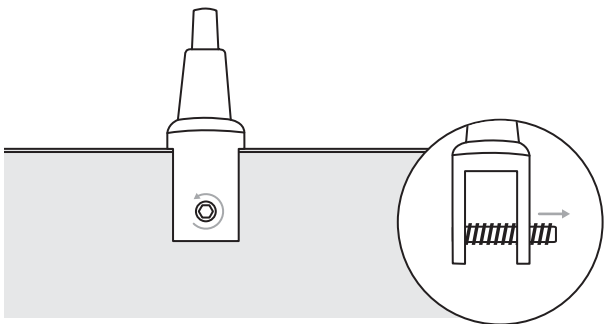

SUSPENSION KIT INSTALLATION

TOOLS REQUIRED

Spirit Level/Laser Level
Pliers
Power Drill (Optional)

STEPS

1 - MARK THE CEILING

Measure and mark the ceiling, using the holes in the Baffle as a reference. Ensure your markings align with the holes in the Baffle.

2 - SCREW INTO THE CEILING

Drill 5/32" hole until you break through drywall and insert drywall anchor.

Attach base to drywall anchor using the provided screw.

Screw the ceiling component of the cable into the base.

3 - ATTACHING THE CONNECTORS

Attach the Baffle connectors by backing out the internal threaded bolt, sliding the connector over the pre-drilled hole, and tightening the screw within the connector.

4 - INSERT THE CABLE

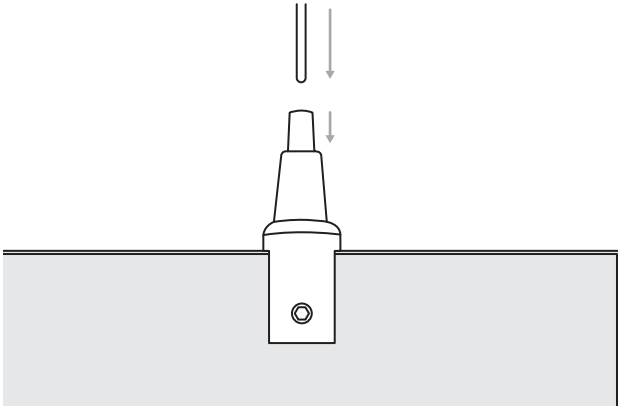

5 - LEVEL IT OUT

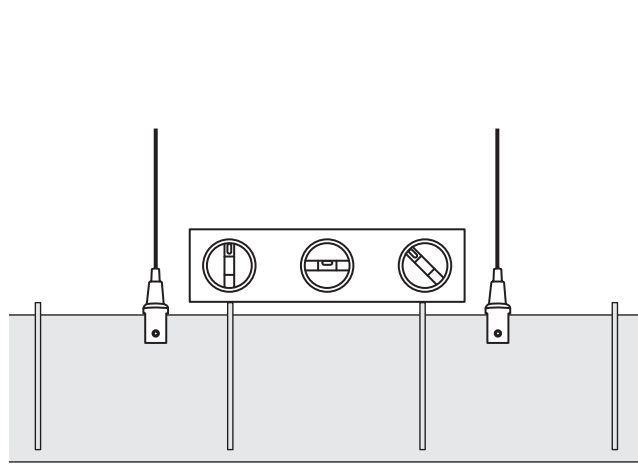

6 - Finished Sus-Kit Installation

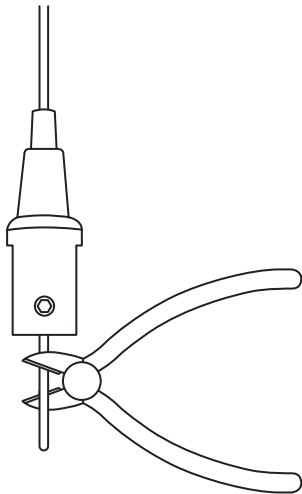

SUSPENSION KIT INSTALLATION

TOOLS REQUIRED

Spirit Level/Laser Level

Pliers

Power Drill (Optional)

STEPS

4 - INSERT THE CABLE

Measure and cut the cable to your desired length, leaving "1"-3" extra length for adjustments. Line up the cable with the baffle connector and insert the cable by simultaneously pushing the spring-loaded top component and sliding the wire into the connector. Repeat each step for each cable.

5 - LEVEL IT OUT

Make sure the baffle is leveled by adjusting the baffle connectors.

6 - Finished Sus-Kit Installation

The 1"-3" extra length for adjustments can now be cut depending on your desired outcome.



HARMONIZE LATTICE CEILING CLOUD

Solving Sound With Design

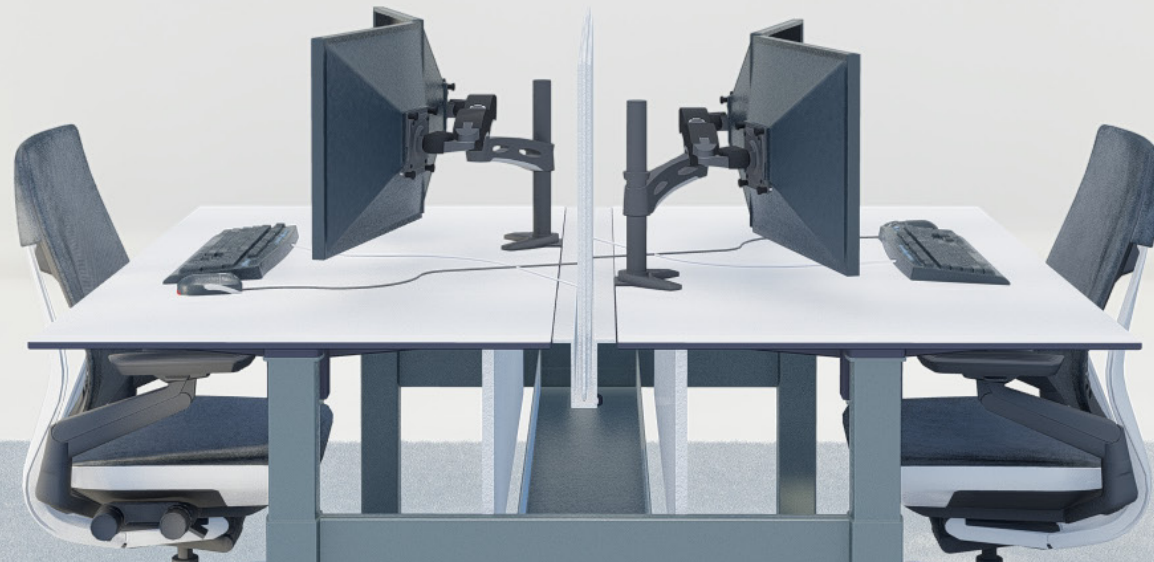

Transform Your Space With Acoustic Innovation

www.OSONIC.com | (732) 659 9262